

Pneumatic diaphragm valve MV300

High performance Low cost

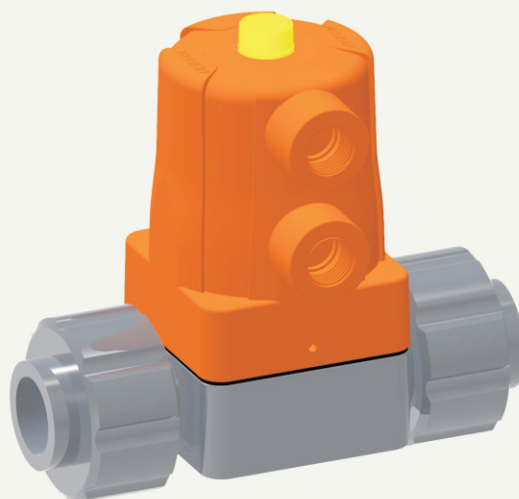

MV300 economic diaphragm valve has a compact one-piece pneumatic actuator structure, and the unique duckbill runner design ensures the best flow capacity. Under the premise of corrosion resistance, We have a variety of materials to ensure cost-effective applications.

Easy installation and maintenance

- * All-in-one compact design ensures the installation in limited space
- * All-plastic appearance is beautiful and corrosion resistant
- * Embedded diaphragm design to make the force uniform and prolong life
- * Super lubricating property, maintenance-free
- * Same sizes and installation length as international brands products
- * Integrated visual position feedback and easy to observe

High safety performance

- * Over pressure margin design of valve body and pneumatic actuator to ensure safety application
- * A variety of materials are available to resistant to high temperature and corrosion
- * The curved channel can ensure the effective closing of the valve in the application of high flow rate
- * Diaphragm compressor is high temperature resistant, which improves sealing performance

High Flexibility

- * True union connection, G thread
- * DIN, JIS and ANSI standards are available
- * Diaphragms are available for EPDM, FPM and EPDM-PTFE
- * Bodies are available for PVC-U, PVC-C, PP-H and PVDF
- * High quality and reliability for high operation times

The best flow performance

- * Superior flow channel makes the linear characteristics of the fluid more precise and controllable
- * The smooth and excessive curved channel has smaller pressure loss, and brings double flow capacity compared with the traditional diaphragm valve
- * Suitable for liquids with small amounts of particles and solids



Technical characteristics

Size	DN 15 (1/2 inch)
Operating pressure	PN 6
Body material	PVC-U PVC-C PP-H PVDF
Diaphragm	EPDM EPDM-PER FPM FPM-70 EPDM-PTFE
Shell	PP-GF Orange
Connector	G Union Socket-end Spigot Butt+IR
Installation	Same sizes and installation length as international brands products
Flow	Double flow capacity
Standard	DIN 8063 ISO 9393

Flow capacity

All data are for 20°C water with 1 bar pressure difference

Material	DN	d	inch	Kv 100	
				l/min	m ³ /h
PVC-U	15	20	1/2"	125	7,5
PVC-C	15	20	1/2"	125	7,5
PP-H	15	20	1/2"	125	7,5
PVDF	15	20	1/2"	125	7,5

$$C_v = k_v \times 0,07 ; F_v = k_v \times 0,0585$$

Kv (l/min) ; Cv (gal/min) US ; Fv (gal/min) GB

Pressure & temperature curve

All data based on water for considering 25 years safe life time

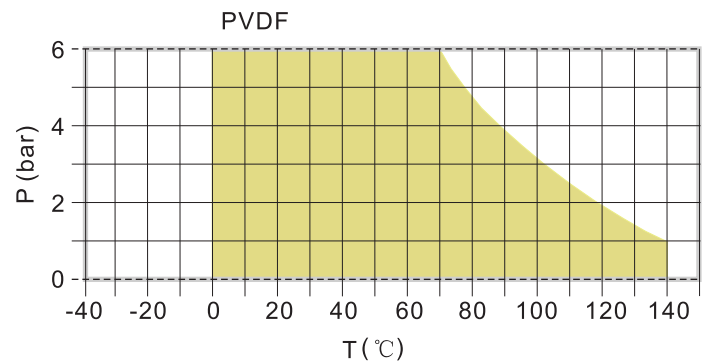
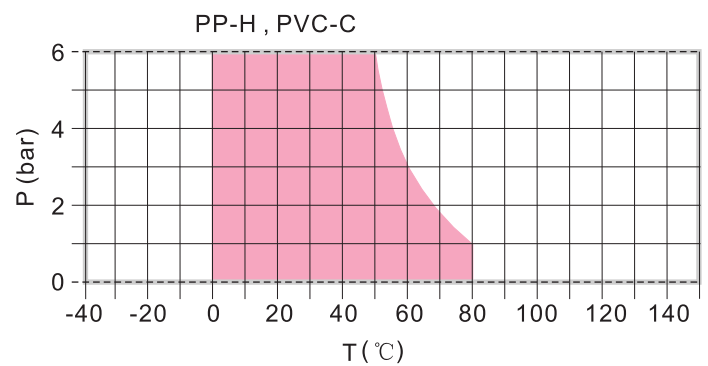
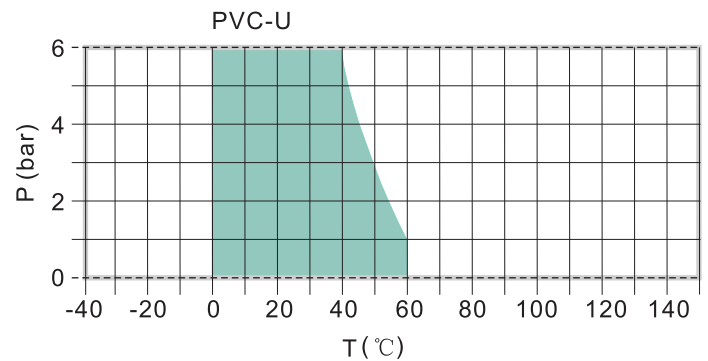

Control pressure

The maximum input value for pressurized air is 6 bar

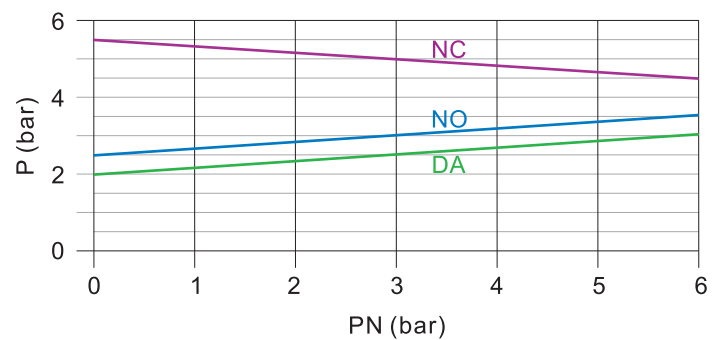

+ Product number

Body PVC-U Actuator variant NC



<i>Size</i>	d (mm)	20			
	DN (mm)	15			
	DN (inch)	1/2			
<i>Pressure range</i>	PN (bar)	6			
		<i>Diaphragm</i>	<i>Sealing</i>	<i>Ident No.</i>	
<i>Connection</i>	PVC-U	EPDM	EPDM	300.012.1020	
		Socket DIN	EPDM-PER	EPDM	300.022.1020
			FPM	FPM	300.032.1020
	FPM-70		FPM	300.042.1020	
			PTFE	FPM	300.062.1020
	PVC-U	EPDM	EPDM	300.012.1220	
		Socket JIS	EPDM-PER	EPDM	300.022.1220
			FPM	FPM	300.032.1220
	FPM-70		FPM	300.042.1220	
			PTFE	FPM	300.062.1220
	PVC-U	EPDM	EPDM	300.012.1420	
		Socket ANSI	EPDM-PER	EPDM	300.022.1420
			FPM	FPM	300.032.1420
	FPM-70		FPM	300.042.1420	
			PTFE	FPM	300.062.1420

Body PVC-U Actuator variant NO

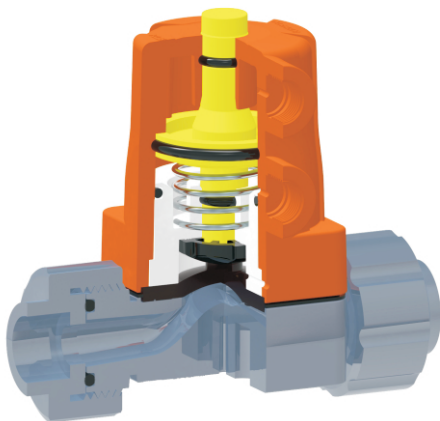

<i>Size</i>	d (mm)	20			
	DN (mm)	15			
	DN (inch)	1/2			
<i>Pressure range</i>	PN (bar)	6			
		<i>Diaphragm</i>	<i>Sealing</i>	<i>Ident No.</i>	
<i>Connection</i>	PVC-U	EPDM	EPDM	300.014.1020	
		Socket DIN	EPDM-PER	EPDM	300.024.1020
			FPM	FPM	300.034.1020
	FPM-70		FPM	300.044.1020	
			PTFE	FPM	300.064.1020
	PVC-U	EPDM	EPDM	300.014.1220	
		Socket JIS	EPDM-PER	EPDM	300.024.1220
			FPM	FPM	300.034.1220
	FPM-70		FPM	300.044.1220	
			PTFE	FPM	300.064.1220
	PVC-U	EPDM	EPDM	300.014.1420	
		Socket ANSI	EPDM-PER	EPDM	300.024.1420
			FPM	FPM	300.034.1420
	FPM-70		FPM	300.044.1420	
			PTFE	FPM	300.0641.420

Body PVC-U Actuator variant DA

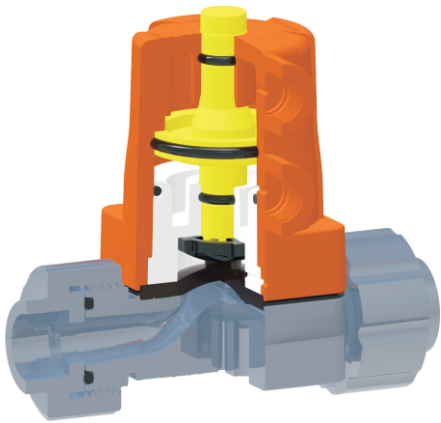

Size	d (mm)	20		
	DN (mm)	15		
	DN (inch)	1/2		
Pressure range	PN (bar)	6		
		Diaphragm	Sealing	Ident No.
Connection	PVC-U	EPDM	EPDM	300.016.1020
	Socket DIN	EPDM-PER	EPDM	300.026.1020
		FPM	FPM	300.036.1020
		FPM-70	FPM	300.046.1020
		PTFE	FPM	300.066.1020
	PVC-U	EPDM	EPDM	300.016.1220
	Socket JIS	EPDM-PER	EPDM	300.026.1220
		FPM	FPM	300.036.1220
		FPM-70	FPM	300.046.1220
		PTFE	FPM	300.066.1220
	PVC-U	EPDM	EPDM	300.016.1420
	Socket ANSI	EPDM-PER	EPDM	300.026.1420
		FPM	FPM	300.036.1420
		FPM-70	FPM	300.046.1420
		PTFE	FPM	300.066.1420

Body CPVC Actuator variant NC

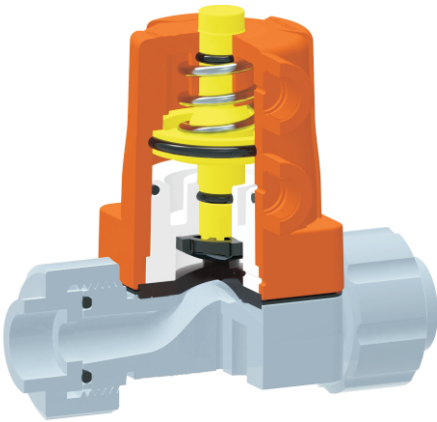

Size	d (mm)	20		
	DN (mm)	15		
	DN (inch)	1/2		
Pressure range	PN (bar)	6		
		Diaphragm	Sealing	Ident No.
Connection	CPVC	EPDM	EPDM	300.212.1020
	Socket DIN	EPDM-PER	EPDM	300.222.1020
		FPM	FPM	300.232.1020
		FPM-70	FPM	300.242.1020
		PTFE	FPM	300.262.1020
	CPVC	EPDM	EPDM	300.212.1220
	Socket JIS	EPDM-PER	EPDM	300.222.1220
		FPM	FPM	300.232.1220
		FPM-70	FPM	300.242.1220
		PTFE	FPM	300.262.1220
	CPVC	EPDM	EPDM	300.212.1420
	Socket ANSI	EPDM-PER	EPDM	300.222.1420
		FPM	FPM	300.232.1420
		FPM-70	FPM	300.242.1420
		PTFE	FPM	300.262.1420

Body CPVC Actuator variant NO

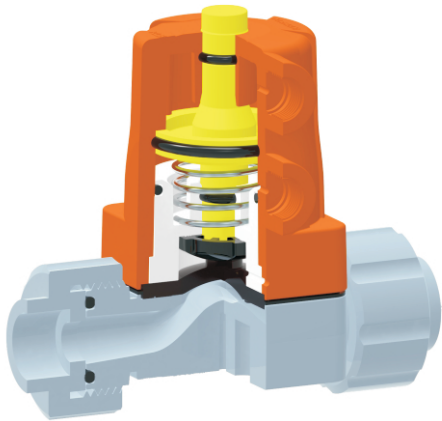

<i>Size</i>	d (mm)	20			
	DN (mm)	15			
	DN (inch)	1/2			
<i>Pressure range</i>	PN (bar)	6			
		<i>Diaphragm</i>	<i>Sealing</i>	<i>Ident No.</i>	
<i>Connection</i>	CPVC	EPDM	EPDM	300.214.1020	
		Socket DIN	EPDM-PER	EPDM	300.224.1020
			FPM	FPM	300.234.1020
			FPM-70	FPM	300.244.1020
			PTFE	FPM	300.264.1020
	CPVC	EPDM	EPDM	300.214.1220	
		Socket JIS	EPDM-PER	EPDM	300.224.1220
			FPM	FPM	300.234.1220
			FPM-70	FPM	300.244.1220
			PTFE	FPM	300.264.1220
	CPVC	EPDM	EPDM	300.214.1420	
		Socket ANSI	EPDM-PER	EPDM	300.224.1420
			FPM	FPM	300.234.1420
			FPM-70	FPM	300.244.1420
			PTFE	FPM	300.264.1420

Body CPVC Actuator variant DA

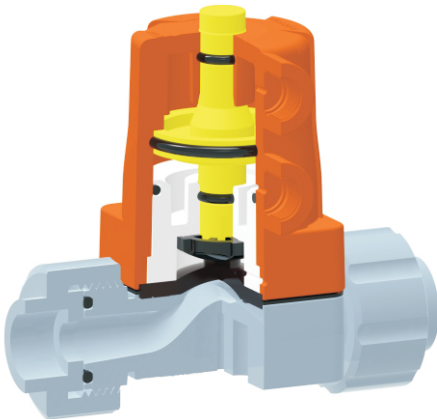

<i>Size</i>	d (mm)	20			
	DN (mm)	15			
	DN (inch)	1/2			
<i>Pressure range</i>	PN (bar)	6			
		<i>Diaphragm</i>	<i>Sealing</i>	<i>Ident No.</i>	
<i>Connection</i>	CPVC	EPDM	EPDM	300.216.1020	
		Socket DIN	EPDM-PER	EPDM	300.226.1020
			FPM	FPM	300.236.1020
			FPM-70	FPM	300.246.1020
			PTFE	FPM	300.266.1020
	CPVC	EPDM	EPDM	300.216.1220	
		Socket JIS	EPDM-PER	EPDM	300.226.1220
			FPM	FPM	300.236.1220
			FPM-70	FPM	300.246.1220
			PTFE	FPM	300.266.1220
	CPVC	EPDM	EPDM	300.216.1420	
		Socket ANSI	EPDM-PER	EPDM	300.226.1420
			FPM	FPM	300.236.1420
			FPM-70	FPM	300.246.1420
			PTFE	FPM	300.266.1420

Body PP-H Actuator variant NC

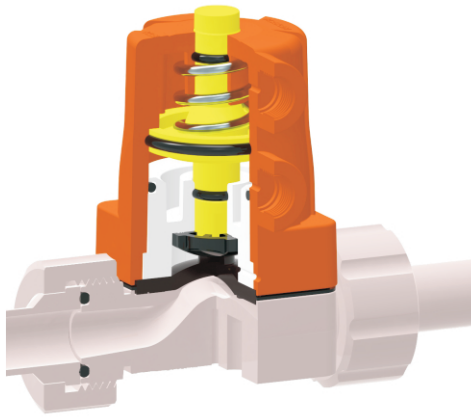

<i>Size</i>	d (mm)	20		
	DN (mm)	15		
	DN (inch)	1/2		
<i>Pressure range</i>	PN (bar)	6		
		<i>Diaphragm</i>	<i>Sealing</i>	<i>Ident No.</i>
<i>Connection</i>	PP-H	EPDM	EPDM	300.412.1020
	Socket DIN	EPDM-PER	EPDM	300.422.1020
		FPM	FPM	300.432.1020
		FPM-70	FPM	300.442.1020
		PTFE	EPDM	300.452.1020
		PTFE	FPM	300.462.1020
	PP-H	EPDM	EPDM	300.412.3020
	Spigot DIN	EPDM-PER	EPDM	300.422.3020
		FPM	FPM	300.432.3020
		FPM-70	FPM	300.442.3020
PTFE		EPDM	300.452.3020	
	PTFE	FPM	300.462.3020	

Body PP-H Actuator variant NO

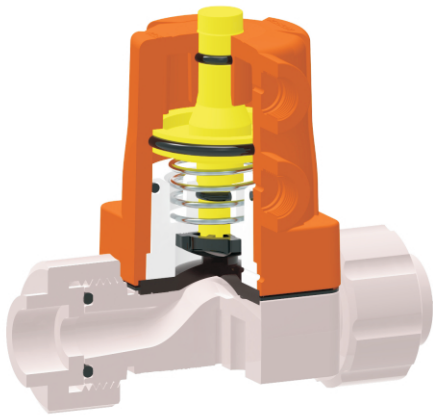

<i>Size</i>	d (mm)	20		
	DN (mm)	15		
	DN (inch)	1/2		
<i>Pressure range</i>	PN (bar)	6		
		<i>Diaphragm</i>	<i>Sealing</i>	<i>Ident No.</i>
<i>Connection</i>	PP-H	EPDM	EPDM	300.414.1020
	Socket DIN	EPDM-PER	EPDM	300.424.1020
		FPM	FPM	300.434.1020
		FPM-70	FPM	300.444.1020
		PTFE	EPDM	300.454.1020
		PTFE	FPM	300.464.1020
	PP-H	EPDM	EPDM	300.414.3020
	Spigot DIN	EPDM-PER	EPDM	300.424.3020
		FPM	FPM	300.434.3020
		FPM-70	FPM	300.444.3020
PTFE		EPDM	300.454.3020	
	PTFE	FPM	300.464.3020	

Body PP-H Actuator variant DA

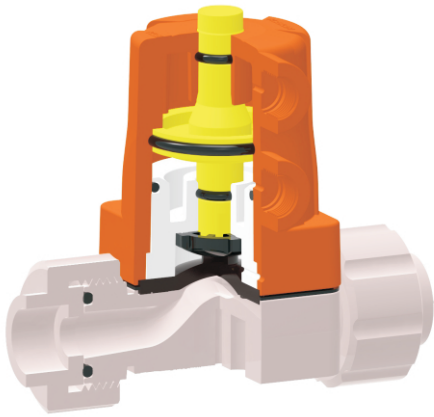

<i>Size</i>	d (mm)	20			
	DN (mm)	15			
	DN (inch)	1/2			
<i>Pressure range</i>	PN (bar)	6			
		<i>Diaphragm</i>	<i>Sealing</i>	<i>Ident No.</i>	
<i>Connection</i>	PP-H	EPDM	EPDM	300.416.1020	
	Socket DIN	EPDM-PER	EPDM	300.426.1020	
		FPM	FPM	300.436.1020	
		FPM-70	FPM	300.446.1020	
		PTFE	EPDM	300.456.1020	
	PP-H	Spigot DIN	EPDM	EPDM	300.416.3020
			EPDM-PER	EPDM	300.426.3020
			FPM	FPM	300.436.3020
			FPM-70	FPM	300.446.3020
		PTFE	EPDM	300.456.3020	
			FPM	300.466.3020	
			EPDM	300.456.3020	
FPM			300.466.3020		

Body PVDF Actuator variant NC

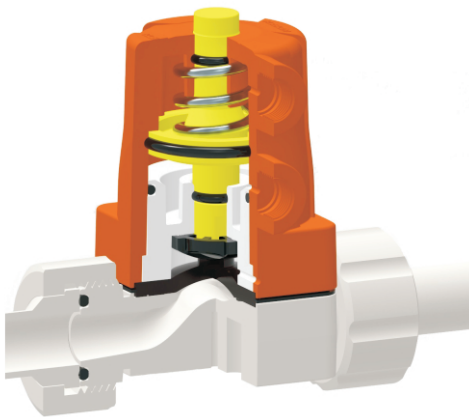

<i>Size</i>	d (mm)	20		
	DN (mm)	15		
	DN (inch)	1/2		
<i>Pressure range</i>	PN (bar)	6		
		<i>Diaphragm</i>	<i>Sealing</i>	<i>Ident No.</i>
<i>Connection</i>	PVDF	FPM	FPM	300.632.1020
	Socket DIN	FPM-70	FPM	300.642.1020
		PTFE	FPM	300.662.1020
		PVDF	EPDM	EPDM
	Spigot DIN	EPDM-PER	EPDM	300.622.3020
		FPM	FPM	300.632.3020
		FPM-70	FPM	300.642.3020
		PTFE	EPDM	300.652.3020
		PTFE	FPM	300.662.3020

Body PVDF Actuator variant NO

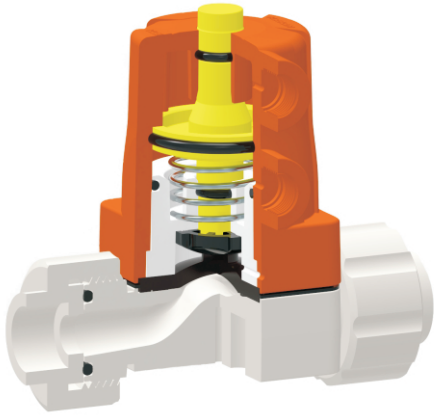

<i>Size</i>	d (mm)	20		
	DN (mm)	15		
	DN (inch)	1/2		
<i>Pressure range</i>	PN (bar)	6		
		<i>Diaphragm</i>	<i>Sealing</i>	<i>Ident No.</i>
<i>Connection</i>	PVDF	FPM	FPM	300.634.1020
	Socket DIN	FPM-70	FPM	300.644.1020
		PTFE	FPM	300.664.1020
		PVDF	EPDM	EPDM
	Spigot DIN	EPDM-PER	EPDM	300.624.3020
		FPM	FPM	300.634.3020
		FPM-70	FPM	300.644.3020
		PTFE	EPDM	300.654.3020
		PTFE	FPM	300.664.3020

Body PVDF Actuator variant DA



<i>Size</i>	d (mm)	20		
	DN (mm)	15		
	DN (inch)	1/2		
<i>Pressure range</i>	PN (bar)	6		
		<i>Diaphragm</i>	<i>Sealing</i>	<i>Ident No.</i>
<i>Connection</i>	PVDF	FPM	FPM	300.636.1020
	Socket DIN	FPM-70	FPM	300.646.1020
		PTFE	FPM	300.666.1020
		PVDF	EPDM	EPDM
	Spigot DIN	EPDM-PER	EPDM	300.626.3020
		FPM	FPM	300.636.3020
		FPM-70	FPM	300.646.3020
		PTFE	EPDM	300.656.3020
		PTFE	FPM	300.666.3020

+ External dimension data

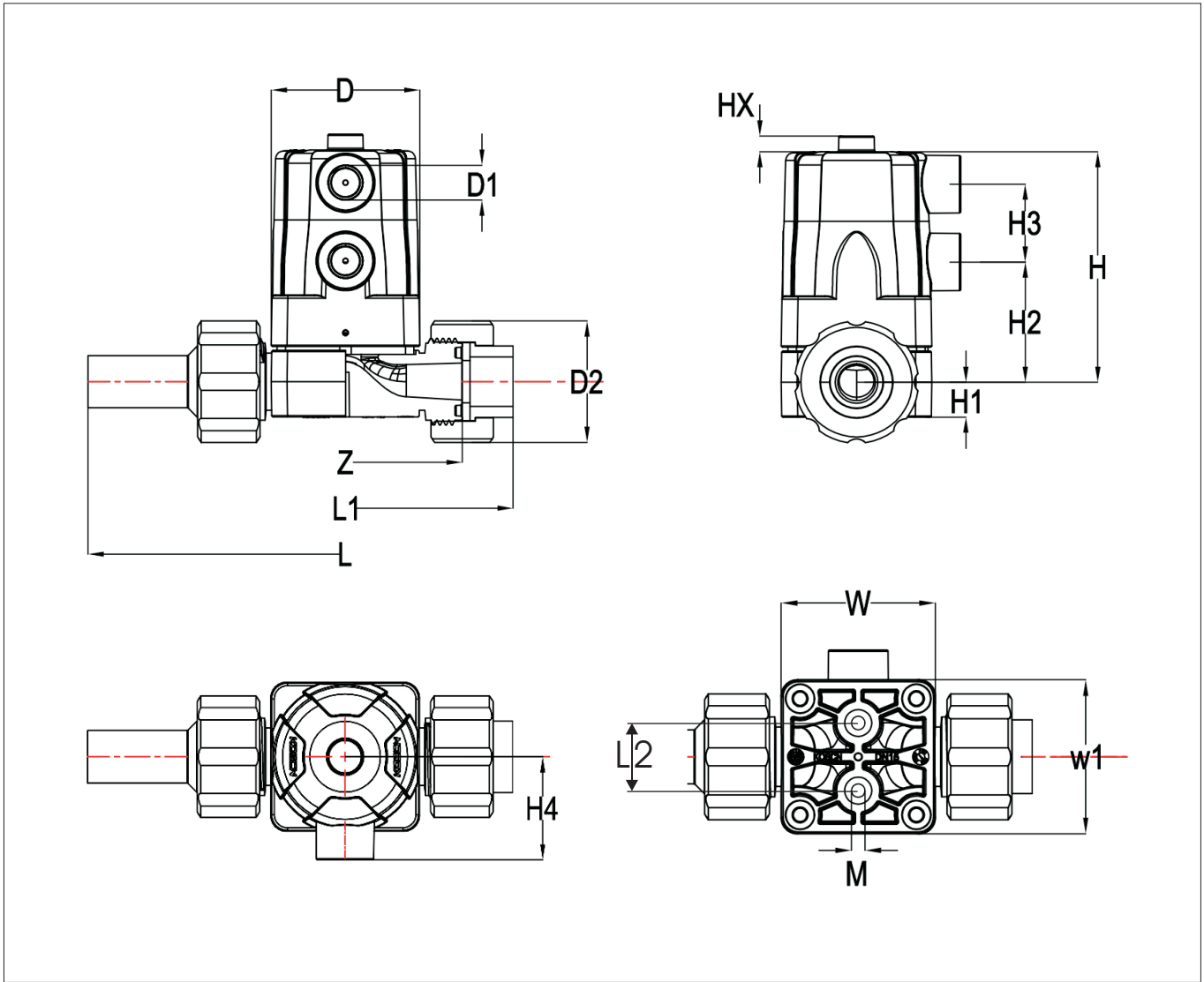

D (mm)	D1_G (mm)	D2 (mm)	H (mm)	H1 (mm)	H2 (mm)	H3 (mm)	H4 (mm)	L (mm)	L1 (mm)	L2 (mm)	M (mm)	Z (mm)	W (mm)	W1 (mm)	Lift = Hx (mm)
57	1/4	46	89	14	46	30	39	198	130	25	6	89	57	57	6

The above dimensions are not binding. They do not constitute a definite property guarantee, nor do they guarantee permanence. Will change as the product is improved or upgraded. This applies to the general terms of sale.

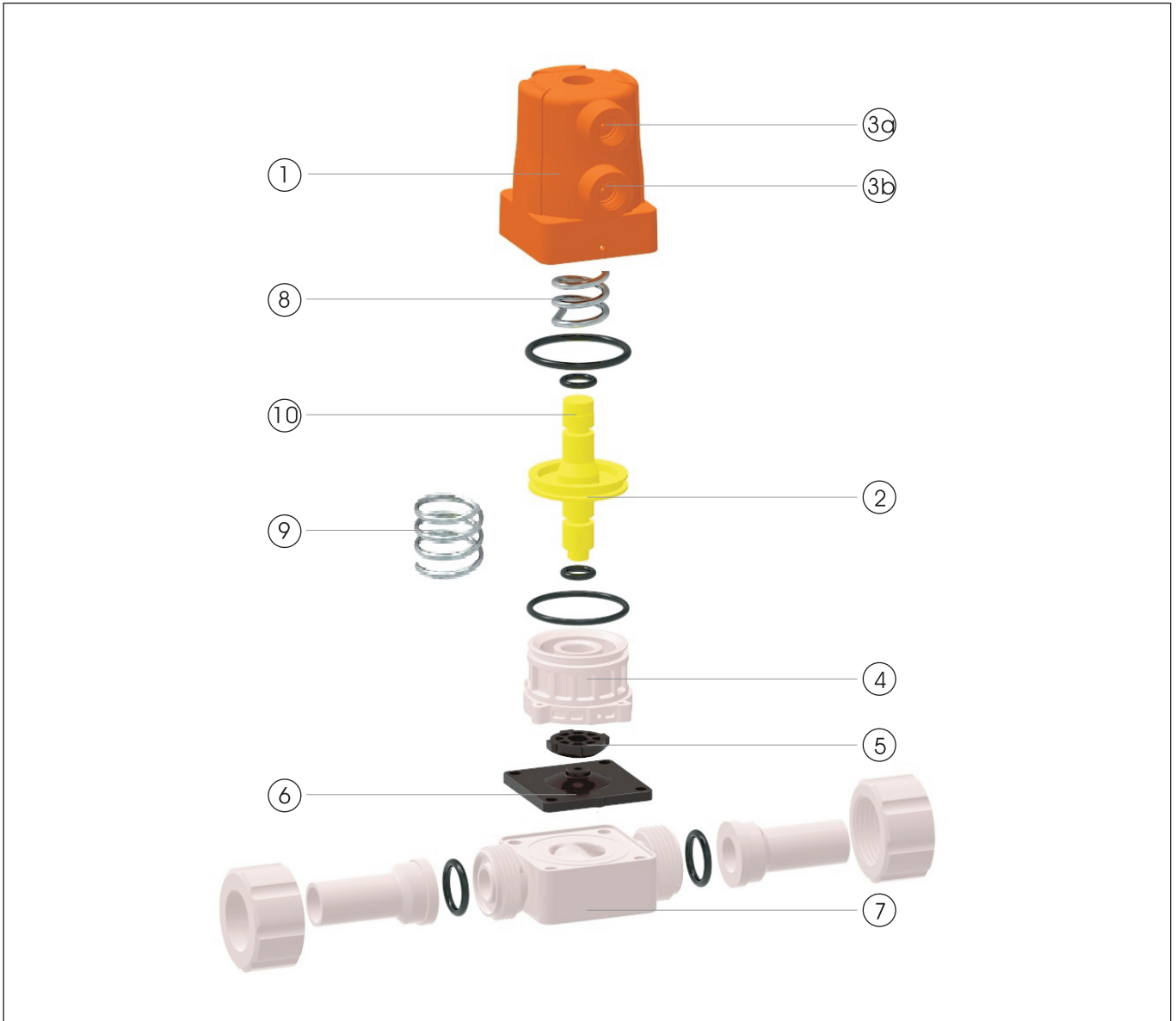

Pos.	Name	Pos.	Name
1	Housing with plastic- plastic connection	5	Compressor
2	Piston	6	Diaphragm
3a	Air connection for NO control mode	7	Valve body
3b	Air connection for NC control mode	8	Spring set for NC mode
3a+3b	Air connections for DA control mode	9	Spring for NO mode
4	Cylinder head base	10	Position Indicator

**contact**
customer center
www.koscn.cn



KOSCN