

LORRIC

Clamp-on Type Ultrasonic Flowmeter
FU-ES Series



QUICKCLAMP X EchoSense

QUICKCLAMP

3 steps in just 3 minutes to get installed



**EXPERIENCE THE FASTEST
INSTALLATION EVER**

EchoSense

Complete all settings in one click

Why Ultrasonic Flowmeter?



No pipe loss

No leakage

No downtime

No pressure drop

No contamination

Non-invasive installation

Skip the hassle of pipe cutting!

QUICKCLAMP

3 steps in just 3 minutes to get installed

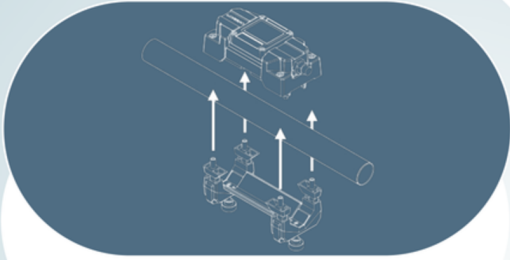

Mount

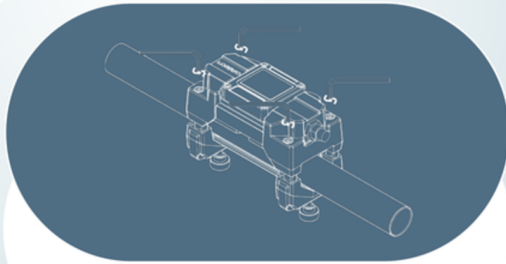

Lock

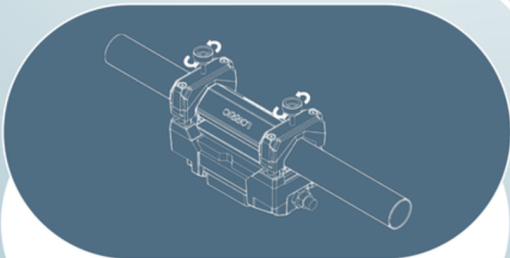

Tighten

3 Steps
Minutes

QUICKCLAMP

3 steps in just 3 minutes to get installed

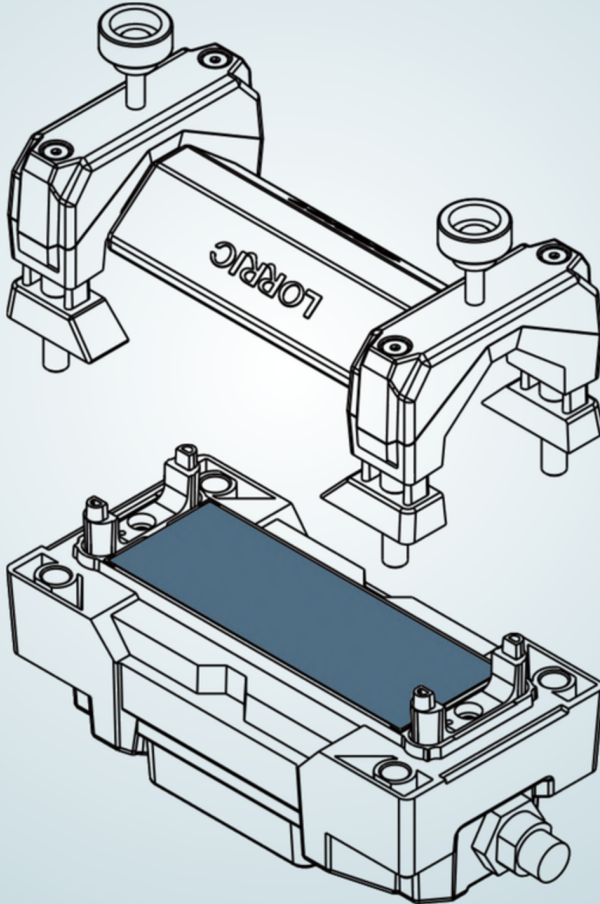

No more ultrasonic gel

LORRIC's "ultrasonic gasket pad" is a hassle-free solution that saves you both time and money. No more dealing with the mess and inconvenience of ultrasonic gel.



QUICKCLAMP

3 steps in just 3 minutes to get installed

Perfect Size for One Hand

Streamlined installation, effortless control. LORRIC's user-friendly design means fewer steps to set up than the rest. Just hold the compact main unit in one hand, secure it with a simple buckle using the other. It's a hassle-free experience, made simple for everyone.

EchoSense

Automatically complete basic settings, effortless setup and instant flow monitoring experience.

Complete all settings in 1 click



Pipe material

Outer diameter

Inner diameter

Pipe thickness

Liquid sound speed

Probe distance

Probe mounting type

EchoSense

Principle & Technology

The EchoSense Ultrasonic flowmeter measures fluid flow by detecting the time difference between signals transmitted from two probes, A and B. This time difference is used to determine the velocity of the fluid, which is combined with the known dimensions of the pipe to calculate the flow rate using the formula $\text{Flow rate} = \text{cross-sectional area} \times \text{flow velocity}$.

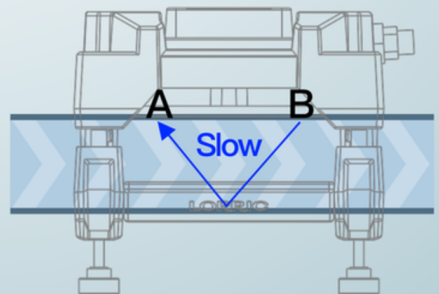
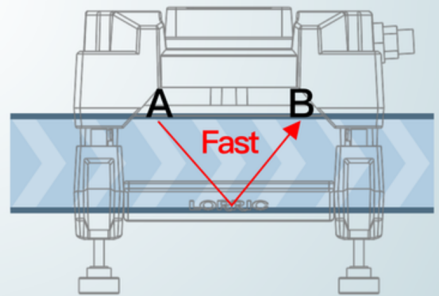
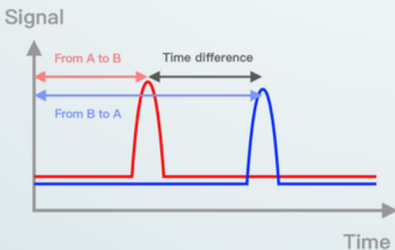

Quantitative accuracy

± 3.0% of RD

LORRIC introduces an exclusive development algorithm to the FU-ES series model. Achieving a remarkable measurement accuracy of $\pm 3.0\%$ of RD, it remains unaffected by environmental or temporal changes thanks to its high-quality material parts.

EchoSense



**Detect problems instantly and intelligently
with this ultrasonic flowmeter using
automatic sensing environment**

Fluid sound velocity change



Pipe is not fully filled with fluid

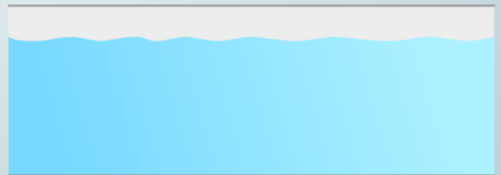

Probes dislocated

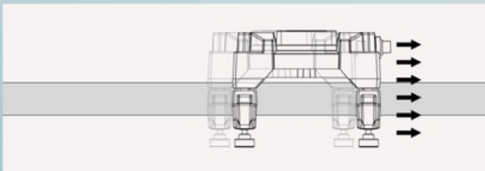

Too many impurities

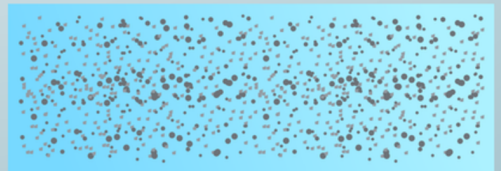

JIS, 1/2 inch pipe



Φ22 x 2.7



Φ22 x 3.0



Φ21.34 x 3.73



Φ20 x 1.5

Automatic Pipe Detection

Unlike traditional ultrasonic flowmeters that demand manual input of pipe diameter and wall thickness, LORRIC's new EchoSense technology automatically detects and configures these settings for you. Enjoy improved efficiency with effortless setup.

EchoSense

Applicable to variety of fluids, pipe materials and diameters.

Applicable fluids



Water



Oil

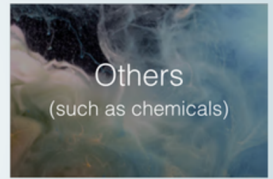

Others
(such as chemicals)

Pipe materials



Stainless Steel

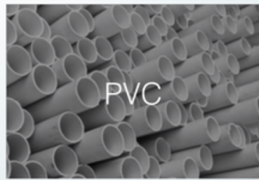

PVC



Others
(such as PP, PVDF, etc.)

Pipe specs

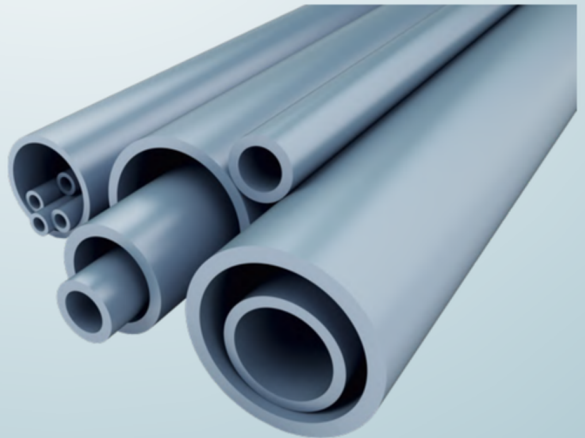

$1/2'' - 3''$

LORRIC

Other reasons you should choose LORRIC

Screen adapts to your pipe:
Vertical or Horizontal



To rotate the display screen,
simply loosen the four screws on
the edge of the display.

LORRIC

Other reasons you should choose LORRIC



Green Normal



Red Error



Orange Setting

Large green, orange and red alarm indicator lights

Patented screen design

Exclusive LCD/LED double screen design



LORRIC

Other reasons you should choose LORRIC

Higher Chemical Resistance

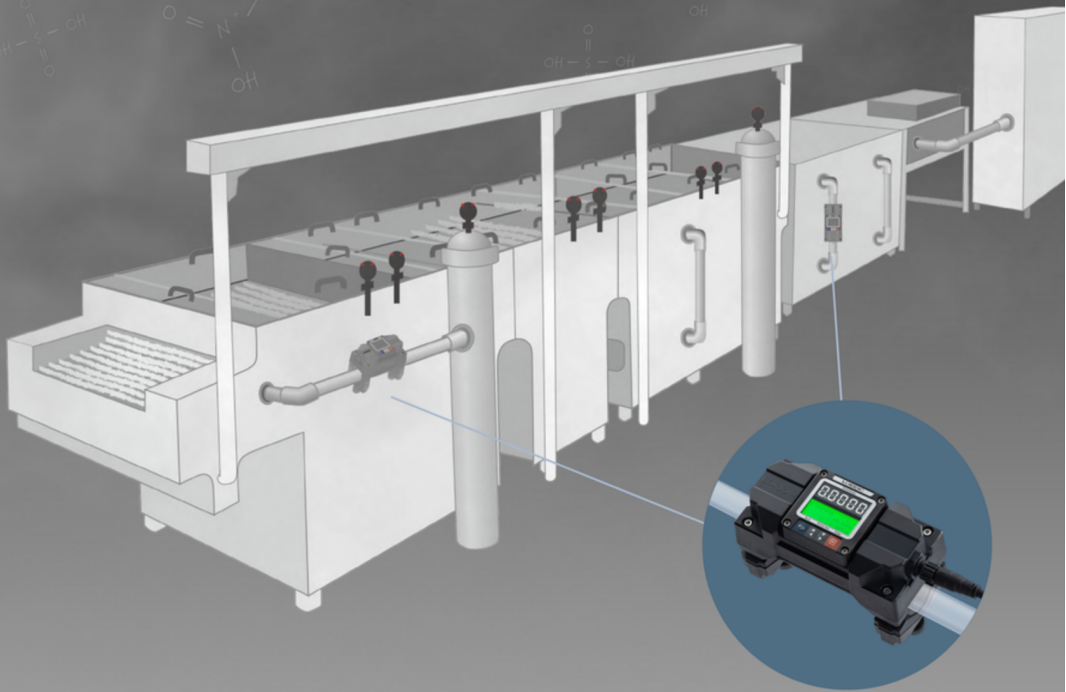

Built tough, the FU-ES: Power-packed with durable engineering plastics like Nylon, PPS, and PEEK, and backed by a stainless steel 304 core.

FU-ES series

Usage Scenarios

Specific fluid

Chemical applications

If the piping is modified to come into contact with harmful chemicals, a non-contact flow meter is ideal for safely measuring the flow.



Easily contaminated liquids

Opt for non-contact flow meters to accurately measure the flow rate when the liquid is sensitive to external materials.

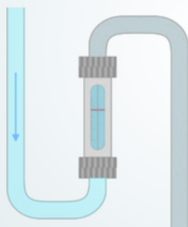

Valuable fluids

To safeguard valuable fluids such as semiconductor optical resistance liquid from wastage, it's crucial to regulate their flow. Non-contact flow meters offer the ideal solution for effective control.



Other Usages

Leasing equipment

Even if the equipment is leased, non-invasive flow meters can still be used for measurement.



Machines containing warranties

Non-invasive flow meters are recommended to prevent unauthorized modifications to pipes that could void the machine's warranty.











Simplify production process notes

Replace manual flow recording with automated non-invasive flow meters.



FU-ES series

Product Series List

	Model	Pipe diameter	Pipe outer diameter range	Recommended flowrate measurement range (May be inconsistent with different pipelines and liquids)	Weight (g)
	FU-ES015	1/2" dn15	20-22 mm 0.79-0.87 inch	1.5-120 LPM 0.4-31.7 gpm	770
	FU-ES020	3/4" dn20	25-27.2 mm 0.98-1.07 inch	2-200 LPM 0.53-52.83 gpm	770
	FU-ES025	1" dn25	32-34 mm 1.26-1.34 inch	3-300 LPM 0.79-79.25 gpm	785
	FU-ES032	1-1/4" dn32	38-42.16 mm 1.5-1.66 inch	5-470 LPM 1.32-124.16 gpm	800
	FU-ES040	1-1/2" dn40	48-50 mm 1.89-1.97 inch	8-770 LPM 2.11-203.41 gpm	1390
	FU-ES050	2" dn50	60-63 mm 2.36-2.48 inch	13-1320 LPM 3.43-348.71 gpm	1540
	FU-ES065	2-1/2" dn65	73-76.3 mm 2.87-3 inch	22-1670 LPM 5.81-441.17 gpm	1580
	FU-ES075	3" dn75	88.9-90 mm 3.5-3.54 inch	30-1870 LPM 7.93-494 gpm	1650

FU-ES series

Product Dimensions



FU-ES015 / FU-ES020 / FU-ES025 / FU-ES032

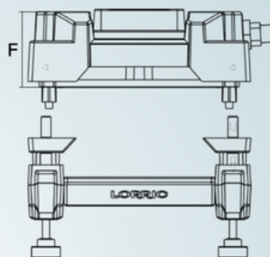
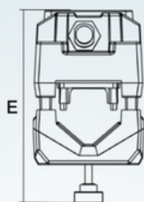
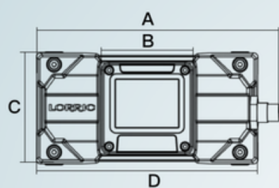

Unit : mm

	A	B	C	D	E	F
FU-ES015 (1/2" / dn15)	169.85	64	79	155	120.53	54
FU-ES020 (3/4" / dn20)	169.85	64	79	155	124.02	54
FU-ES025 (1" / dn25)	169.85	64	79	155	133.52	54
FU-ES032 (1-1/4" / dn32)	169.85	64	79	155	143.02	54

FU-ES040 / FU-ES050 / FU-ES065 / FU-ES075

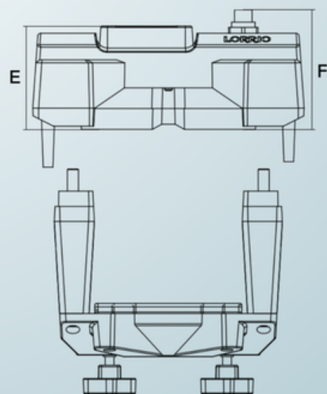
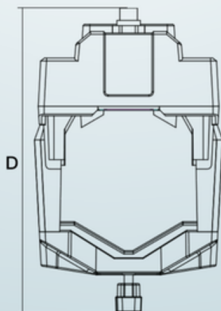
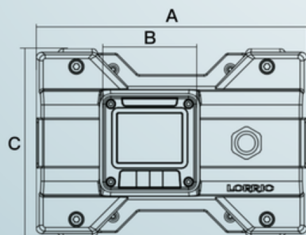

Unit : mm

	A	B	C	D	E	F
FU-ES040 (1-1/2" / dn40)	184.90	64	125.22	164.12	53.50	69.50
FU-ES050 (2" / dn50)	184.90	64	125.30	178.12	53.50	69.50
FU-ES065 (2-1/2" / dn65)	184.90	64	126.87	193.12	53.50	69.50
FU-ES075 (3" / dn75)	184.90	64	128.55	207.12	53.50	69.50

FU-ES series

Product Specs

	FU-ES015	FU-ES020	FU-ES025	FU-ES032	FU-ES040	FU-ES050	FU-ES065	FU-ES075
Installation method	Outside the pipe (clamp-on type)							
Applicable diameter	20-22 mm 0.79-0.87 inch	25-27.2 mm 0.98-1.07 inch	32-34 mm 1.26-1.34 inch	38-42.16 mm 1.5-1.66 inch	48-50 mm 1.89-1.97 inch	60-63 mm 2.36-2.48 inch	73-76.3 mm 2.87-3 inch	88.9-90 mm 3.5-3.54 inch
Applicable pipe material	Metal pipe, Plastic pipe (UPVC / PPH / PVDF / PFA / PTFE)							
Applicable fluid	Various liquids (no impurities or air bubbles)							
Velocity range	0 ~ 85°C (no ice on the piping surface)							
Temperature	± 0.3 to 6.0 m/s recommended, ± 0.1 to 10m/s measurable							
Flow range	1.5-120 LPM 0.4-31.7 gpm	2-200 LPM 0.53-52.83 gpm	3-300 LPM 0.79-79.25 gpm	5-470 LPM 1.32-124.16 gpm	8-770 LPM 2.11-203.41 gpm	13-1320 LPM 3.43-348.71 gpm	22-1670 LPM 5.81-441.17 gpm	30-1870 LPM 7.93-494 gpm
Language	English, Traditional and Simplified Chinese (others can be customized)							
Units	Metric - Meters, Cubic Meters, Liters Time - Seconds, Minutes, Hours, Days Imperial - Feet, Cubic Feet, UK gallon, US gallon							
Display mode	Dual screen display: 5-digit LED + 3-color backlight, 3-line 16-character LCD							
Display update cycle	0.5s, 1s							
Measurement Accuracy	±3.0% RD at 10% to 100% of F.S. ^{*1} ±0.3% F.S. at 0% to 10% of F.S. ^{*1}							
Display resolution	Maximum resolution 0.0001 (finest)							
Power demand	DC 12V to 36V							
Power I/O Connector	M12 8-pin connector							
Input / Output	Analog output with self-powered 16-bit 4-20mA Modbus RTU RS485 two-wire optocoupler switch signal (with 2 meters long signal line)							
Consumption current	<200mA@12V when starting up and working stably (not included in the communication current)							
Protection circuit	Power reverse connection protection, power surge protection							
Waterproof level	IP66 ^{*2}							
Ambient temperature	-10 ~ 60°C (no freezing)							
Relative humidity	35~ 85%RH (non-condensing)							
Material	PPS+GF、PEEK、NBR、Silicon、PA66+GF、PC+GF、SS304、PMMA							
Weight (g)	770	770	785	800	1390	1540	1580	1650

*1 The measurement accuracy is established in a controlled laboratory environment where the pipe and fluid conditions are set and the instrument is calibrated to zero before conducting tests at 25°C. Although statistical results are obtained under these conditions, there may be variances in accuracy when used in customer environments.

*2 Incorrect installation when rotating the screen by loosening the screws around it may affect the IP66 waterproof protection.

FU-ES series

Installation Precautions

Extremely important precautions to take note before installing!!

If any of the scenarios below occur and cause damage to the flowmeter, the warranty is void.

1. If the device material is PC then it is not highly resistant to PVC glue which is a strong gas and lubricant for PVC pipe. Therefore, before installing the flowmeter you must ensure that the glue is dry between the connecting pipe and adapter.
2. Please pay special attention to the vertical flow of solvents and chemicals outside the pipeline since it may potentially cause damage to the flowmeter
3. Do not use this device as a support point for pipelines or other objects, which will cause the flowmeter to withstand external forces which it is not designed for, thus, shortening the usage life of the product or damaging it.
4. During the installation process, it's crucial to tighten the union nuts only by hand until the flowmeter does not move and rotate. Do not use iron pliers or other tools to avoid damage to the flowmeter.
5. The flowmeter is not permanently fixed to the outside of the pipeline, and can still move and rotate under excessive external force. Please do not use the flowmeter as a structure for personnel fixing, moving and safety protection.
6. The electronic device of the flowmeter is not UV resistant. Therefore, we suggest covering it with a protector if installed outdoors.
7. The seller will not be responsible for free maintenance for any defect or malfunction incurred by improper use and human errors.
8. If the flowmeter is transported with its piping system to another site without protection then it could be damaged.

How to Choose an Installation Location

The 1st principle for choosing an installation location is wherein the pipe is filled completely with liquid to avoid issues caused by air bubbles or precipitation in the pipe. The 2nd principle is allowing the flow in the pipe to be fully developed by having enough length on both sides of the straight pipe. This means no equipment should be left on either side like adaptors, elbow pipe, valves or pumps.

The LCD display screen should not be exposed to direct sunlight that could cause visibility issues and a shorter life usage. Therefore, installing the flowmeter under direct sunlight should be avoided or with a sunlight protector is recommended.

Vertical pipe

Please choose the vertical pipe with a bottom-up flow direction.

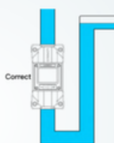

Horizontal pipe

Please choose the location with full liquid, like the lower part of the inclined pipe.

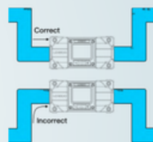

LORRIC's EchoSense flow meter should not be installed at the top right or bottom side of the pipe in order to avoid the interruption of air bubbles or precipitation.



Please be cautious of the air bubble in the pipe to avoid measurement error.

If the installation location for the flowmeter is close to a tank where pressure is low. We recommend installing a valve at the pipe exit to avoid generating any air bubbles.

If air bubbles are frequently generated in the pipe, it may lead to a large non-reproducible measurement error which should be avoided.

New Product Installation Process

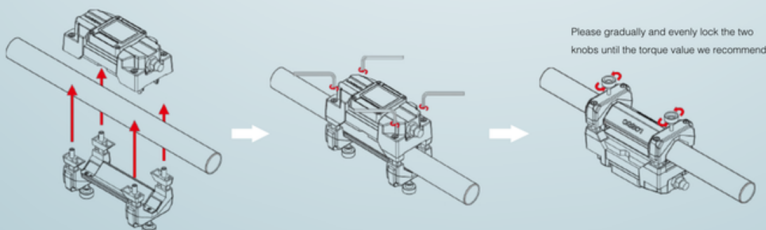

The buckle must be released before installation.

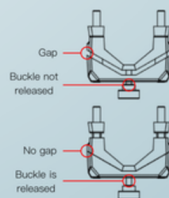

1. Make sure that the buckle is in the released position.
 2. After the device faces the intended operation direction, pre-lock the device and the buckle on both sides of the pipeline with screws. At this time, if it is a large pipe in the applicable pipeline, the device may not move. If it is a small pipe in the applicable pipeline and the device is still in a movable state, please lock the flowmeter.
 3. Tighten the two knobs on the fastener by hand, as long as the device does not rotate and move.
 4. Finished.
- *The torque value of the knob should be between 0.20 N-m (2kgf-cm) and 0.35 N-m (3.5kgf-cm), and should not exceed 0.4 N-m (4.0kgf-cm), which will damage or shorten the life of the flowmeter.



LORRIC

United Benefit Corp.

8F, No.3, Lane 83, Sec. 1, Guangfu Rd.,
Sanchong Dist. New Taipei City

TEL : +886-2-8511-2135

FAX : +886-2-8511-2097

E-mail : sales@lorric.com

www.lorric.com



FU-ES series website



FU-ES instruction manual